

CATALOGUE



The Lighting Company
The Future Company
www.dgr.com.my



PENDANT LIGHT

PENDANT LIGHT

FUNCTIONAL DECORATIVE LIGHT MIRACH



The Lighting Company

SPECIFICATION

CASING

Silver powered coated pendant to color code RL9006
 Complete with 3MM toughened glass for F&B safety standards
 Includes of 3M suspension and electrical cables
 Opal glass reflector D300
 Housing die-cast aluminium
 National safety marks enec
 Integral electronic control gear
 International energy label Class A
 IP 20
 Designed, manufactured and complied with MS: IEC 60998 and IEC 61347



CODE

0039100
 0039101
 0039102
 0039103
 0039105
 0039106
 0039107
 0039108

DESCRIPTION

Mirach CMI-T 70
 Mirach CMI-T 150
 Mirach CMI-70 HF
 Mirach CMI-T 150 HF
 Mirach 2x26 Lynx-D
 Mirach 3x26 Lynx-D
 Mirach 2x26/32/42 Lynx-DE
 Mirach 3x26/32/42 Lynx-DE



* with prismatic reflector ** with opal and aluminium reflectors

DIMENSION , mm

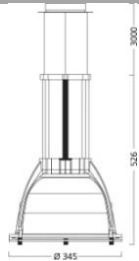

DIAMETER: Ø345mm x LENGTH 526mm + 3000mm

PHOTOMETRIC DATA

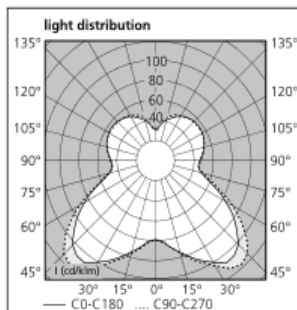

Note:

Testing environment temperature: 25 ± 2°C.

The above parameters are typical data; the actual parameters of each single product could differ from the typical data.

The data are subject to change without prior notice.



DML GLOBAL RESOURCES SDN BHD (875817-D)

NO.43, JALAN BP 6/2, BANDAR BUKIT PUCHONG, 47100 PUCHONG, SELANGOR DARUL EHSAN, MALAYSIA.

TEL : 011 1533 2886 FAX: +603 8051 3783 WEBSITE: www.dgr.com.my

Email: sales@dgr.com.my

PENDANT LIGHT



The Lighting Company

FUNCTIONAL LED PENDANT LIGHT CASSINI LED PLANAR

SPECIFICATION

CASING

Housing made of clear polycarbonate and aluminium with polycarbonate opal diffuser cover
 Housing color in brushed aluminium. Black RAL9005, Silver 9006 and White RAL9016
 Excellent flashing provides perfect homogenous light distribution with halo backlight
 Distribution type: Symmetrical
 Reflector material using FR4 PCB BOARD
 LED made of SAMSUNG 2323 LED
 Color temperature 3000k
 Energy Label A++
 Control gear electronic intergral with high output and high efficiency flick switch
 Power 22W HO or 12W HE
 IP 65 Fitting Resistant to dust and water jet ingress
 Tamper resistant lock
 Ceiling, pendant or wall mounted
 Option to add microwave sensor for maximum energy savings
 50,000 hrs life span
 Approval Mark

Concord



DESCRIPTION	LAMP/ mA	FIXTURE (Lumens)	TOTAL (W)
Cassini LED Planar 3K	HE 350mA	666	12
Cassini LED Planar 3K	HO 700mA	1244	22
Cassini LED Planar 4K	HE 350mA	725	12
Cassini LED Planar 4K	HO 700mA	1354	22
Cassini	28W 2D	675	32
Cassini	2x26W TC D	1332	56



DIMENSION , mm

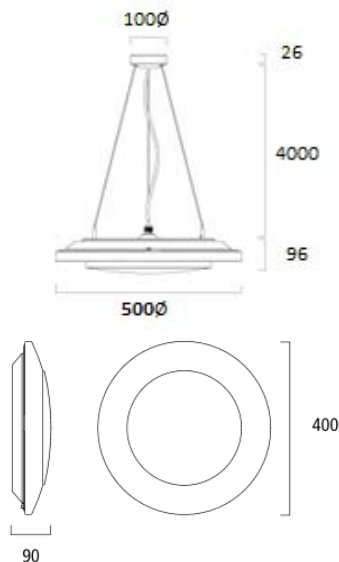

PHOTOMETRIC DATA

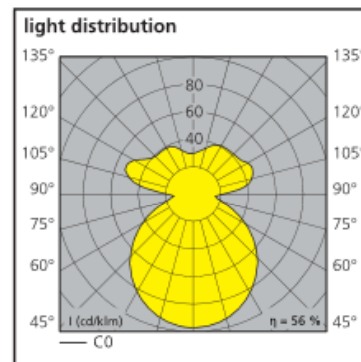

Note:

Testing environment temperature: 25 ± 2°C.

The above parameters are typical data; the actual parameters of each single product could differ from the typical data.

The data are subject to change without prior notice.

DML GLOBAL RESOURCES SDN BHD (875817-D)

NO.43, JALAN BP 6/2, BANDAR BUKIT PUCHONG, 47100 PUCHONG, SELANGOR DARUL EHSAN, MALAYSIA.

TEL : 011 1533 2886 FAX: +603 8051 3783 WEBSITE: www.dgr.com.my

Email: sales@dgr.com.my

D' PENDANT

DECORATIVE LIGHTING SERIES



The Lighting Company

SPECIFICATION

LAMP

LED: Sylvania / Osram / Lemnis / Philips

Types of Lamp: LED bulb A60

Lamp Base: E27

Power: 10W

Input: 220-240V, 50/60Hz

Power Factor: 0.9

Luminous Flux: 810lm

Beam Angle: 25 °

CCT: 2700K - 3000 K

CRI: >80Ra



CASING

Aluminium with glossy surface in stylish appearance

Suspended cable provided with 1.5 meter length

Cap material NCKEL plated brass

DIMENSION , mm

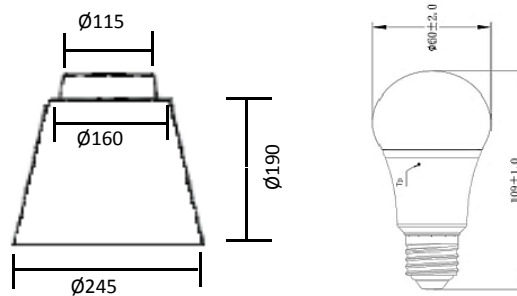

PHOTOMETRIC DATA

PHOTOMETRIC GRAPHICS:

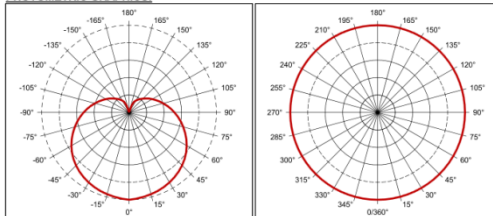

SPECTRAL GRAPHICS:

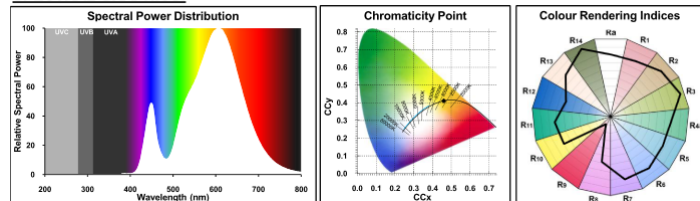

Note:

Testing environment temperature: 25 ± 2°C.

The above parameters are typical data; the actual parameters of each single product could differ from the typical data.

The data are subject to change without prior notice.

DML GLOBAL RESOURCES SDN BHD (875817-D)

NO.43, JALAN BP 6/2, BANDAR BUKIT PUCHONG, 47100 PUCHONG, SELANGOR DARUL EHSAN, MALAYSIA.

TEL : 011 1533 2886 FAX: +603 8051 3783 WEBSITE: www.dgr.com.my

Email: sales@dgr.com.my

LED PENDANT LIGHT

DECORATIVE LIGHTING

Onion Series



The Lighting Company



Widely used in Home lighting, advertising lights, museums, corridors, show-windows, casino, bars, shopping malls, exhibition, meeting rooms, showrooms ,museums, art galleries, etc.

SPECIFICATION

Model	Onion series	
Lamp Power	9W/12W	15W/18W
Dimension (Ø x H) mm	Ø180 x 155mm	Ø200 x 180mm
Rate Voltage	AC(85V-265V) / 50H~60Hz	
Body color	Red / Yellow/ Green/ Black /White	
Light color	WW/ CW/ DL	
Operation Temperature	-20° ~ 50°C	

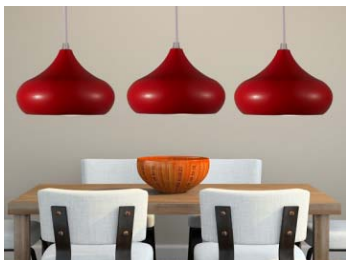

Dimmable
UPON REQUEST



Note:

Testing environment temperature: 25 ± 2°C.

The above parameters are typical data; the actual parameters of each single product could differ from the typical data.

The data are subject to change without prior notice.

DML GLOBAL RESOURCES SDN BHD (875817-D)

NO.43, JALAN BP 6/2, BANDAR BUKIT PUCHONG, 47100 PUCHONG, SELANGOR DARUL EHSAN, MALAYSIA.

TEL : 011 1533 2886 FAX: +603 8051 3783 WEBSITE: www.dgr.com.my

Email: sales@dgr.com.my

LED PENDANT LIGHT

DECORATIVE LIGHTING

Apple Series



The Lighting Company

SPECIFICATION

Model	Apple series		
Lamp Power	5W/7W	9W/12W	15W/18W
Rate Voltage	AC(85V-265V) / 50H~60Hz		
Body color	Red / yellow/ green/ black /white		
Light color	WW/ CW/ DL		
Dimension (Ø x H) mm	Ø120 x 110mm	Ø150 x 120mm	Ø200 x 190mm
Operation Temperature	-20° ~ 50°C		



Dimmable
UPON REQUEST



Note:

Testing environment temperature: 25 ± 2°C.

The above parameters are typical data; the actual parameters of each single product could differ from the typical data.

The data are subject to change without prior notice.

DML GLOBAL RESOURCES SDN BHD (875817-D)

NO.43, JALAN BP 6/2, BANDAR BUKIT PUCHONG, 47100 PUCHONG, SELANGOR DARUL EHSAN, MALAYSIA.

TEL : 011 1533 2886 FAX: +603 8051 3783 WEBSITE: www.dgr.com.my

Email: sales@dgr.com.my